

Article number: 021816011167

Description: Clamp with bracket and rubber
SPGU 6011. 167/30 SK

Measures

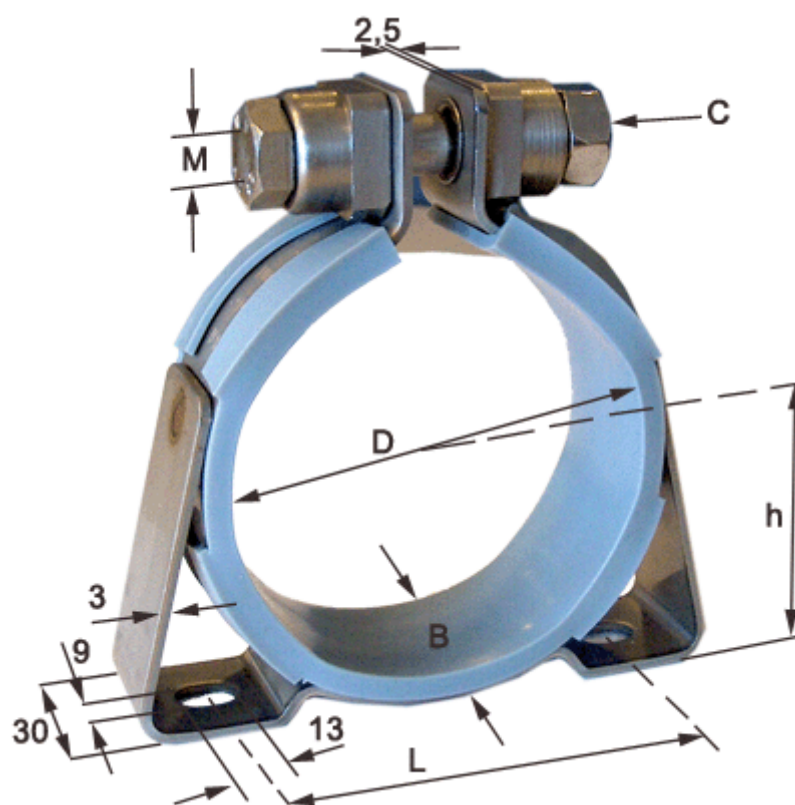

C (screw type) = SK hexagon screw

Diameter D = 167

h = 92

L = 148

Width B = 30